

Sheet: ADSR THT Component Board

File: ADSR THT Component Board.sch

H1 Mounting Hole

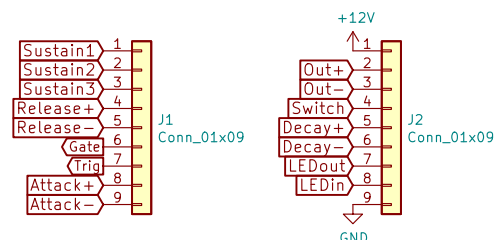
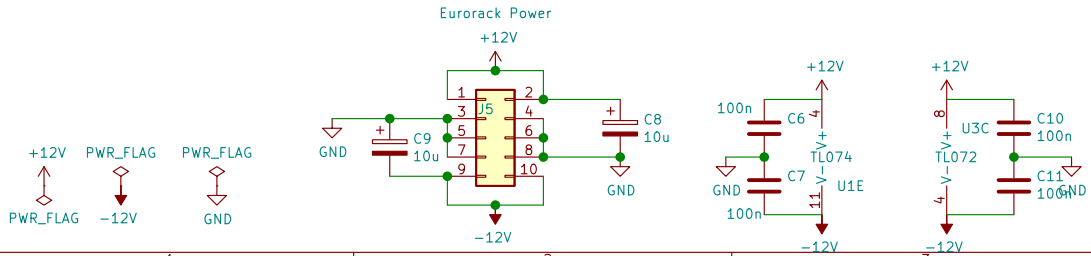
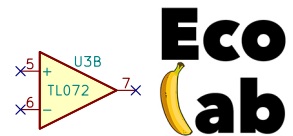

Sheet: /		Date:	
File: ADSR THT.sch		Rev:	
Size: A4	KiCad E.D.A. eeschema (5.1.5-0)		Id: 1/2

Gate Conditioning

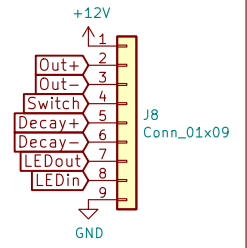
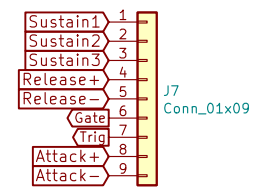
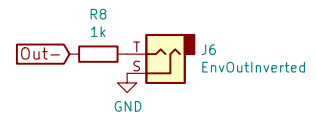
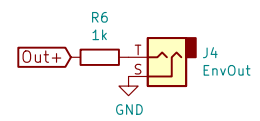
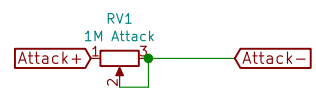
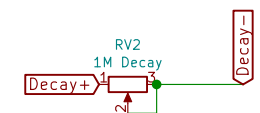
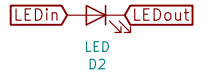
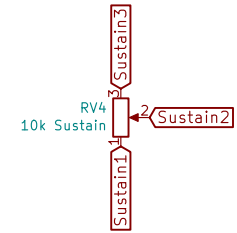
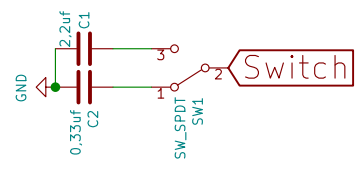
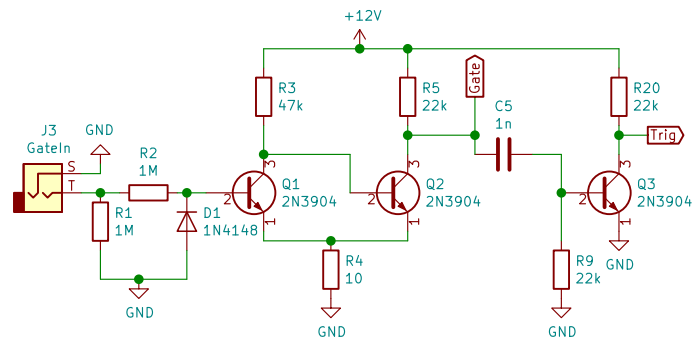

Sheet: /ADSR THT Component Board/
 File: ADSR THT Component Board.sch

Title:	
Size: A4	Date:
KiCad E.D.A. eeschema (5.1.5-0)	Rev:
	Id: 2/2